

HOSKEN

STEEL PALLET

FOR CONCRETE PRODUCTS

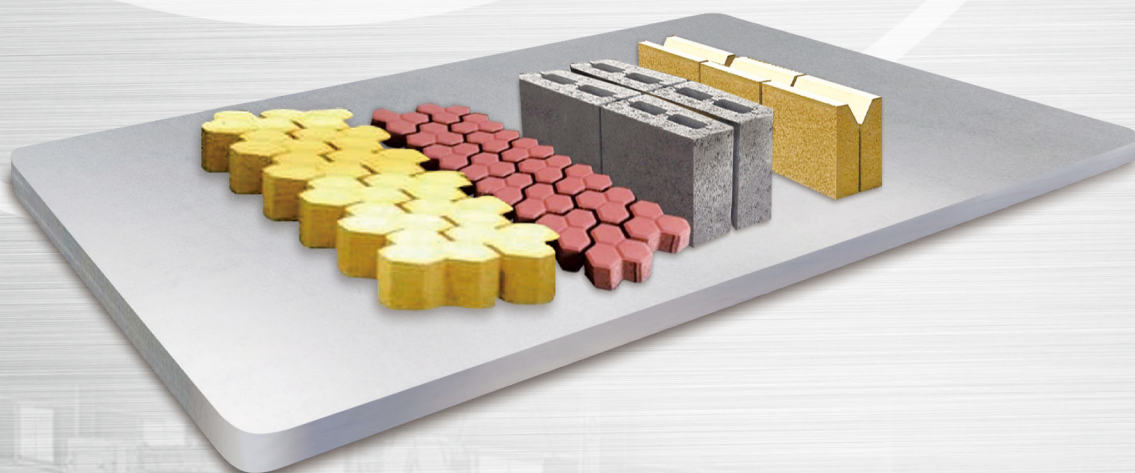

HOSKEN STEEL CO.,LTD.

Hosken Steel was established in 2007 and is one of the largest manufacturers and exporters in South Korea which specializes in steel pallets for concrete block plants.

Our fully automated production facilities are located in Pohang, approximately 250 miles southeast of Seoul, the capital of Korea. We are equipped with an innovative production line which improves productivity as well as reducing manufacturing costs. As a result, Hosken is able to offer the highest quality products, more competitive prices.

Our steel pallets are uniquely designed by our customers own specifications. Due to Hosken emphasis in customer satisfaction, it has been exponentially growing. With customers all over the world, Hosken Steel has become a global leader in manufacturing steel pallets which has become well known in the Middle East, Asia and Europe.

Customer satisfaction is our primary focus and we will do our best to meet customers expectations. Thank you.

President *Sang Keum Kim.*



STEEL PALLET FOR CONCRETE PRODUCTS

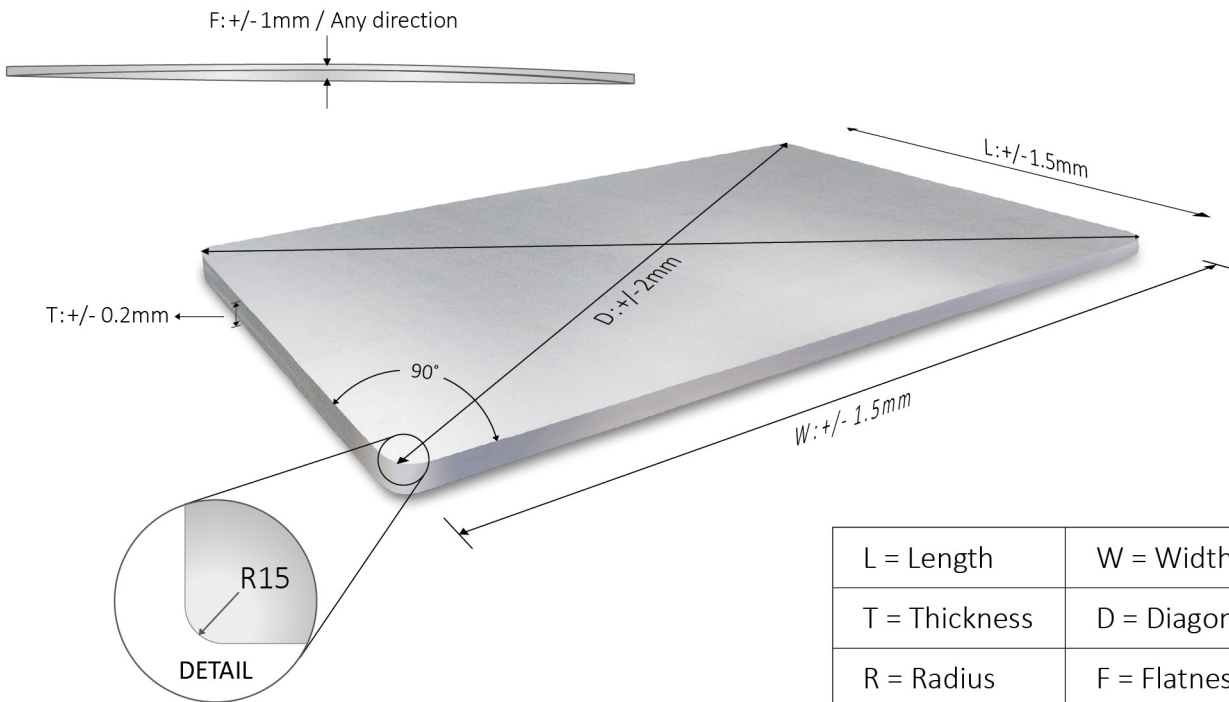

PRODUCTION LINE AND SPECIFICATION



► **Leveling** : At the beginning, middle and final process

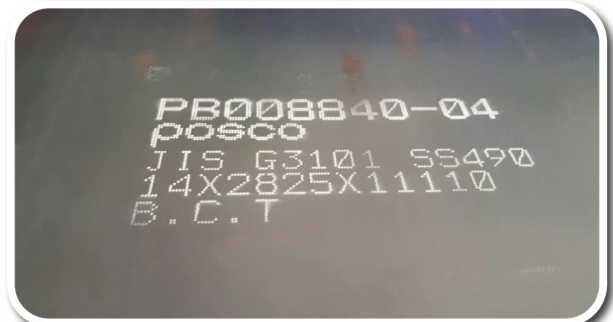
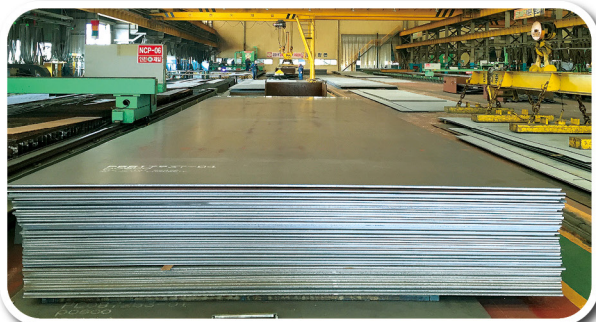

► **Material** : We use 100% POSCO-produced plates as raw material. Our partnership with POSCO get price reduction as well as smooth material supply on-time delivery. We will prove the fame and quality of the world-renowned POSCO.

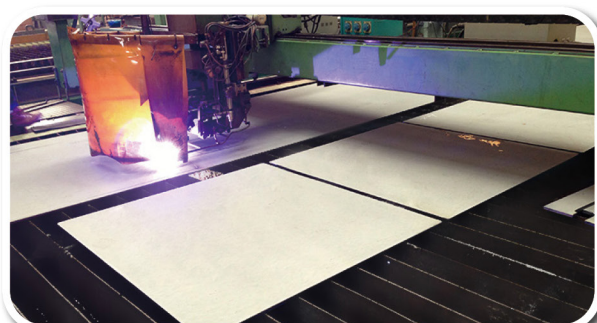

► **Cutting Process** : We have mega size CNC plasma cutting equipment. Outstanding cutting equipment enable more accurate figures and cleaner (neater) cutting work.

► **Perfect close(Broaching and Grinding)**

To minimize the issue of safety that may occur in using product, we produce it with all corners smoothly.

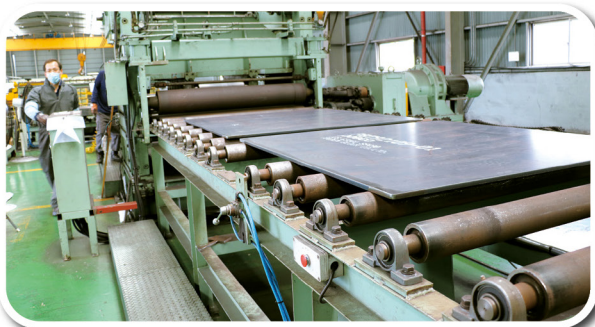

► **Flatness** : +/- 1mm / Any direction

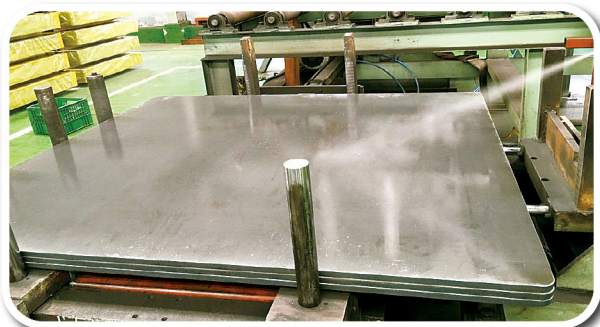

► **Spread antirust oil**



► **Shipment** : load into 20ft container. Steel pallet will be delivery fast and safety by ship all round the world.
► **Max weight** : 21 Ton per container



INSPECTION MANUAL

◇ Product Inspection (Steel Pallet) ◇

① MEASUREMENT OF STEEL PALLET

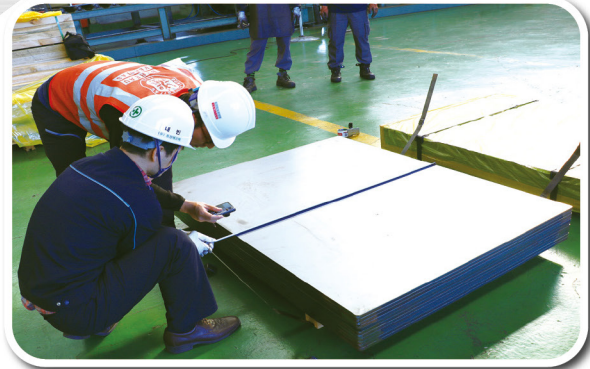

Length & Width : +/-1.5mm

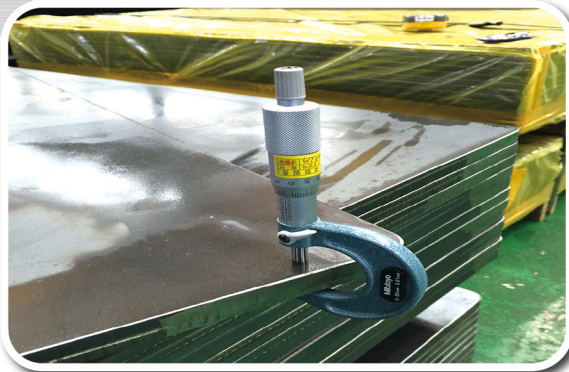

Thickness : +/- 0.2mm



Flatness : +/-1mm/any direction



Diagonal : +/- 2mm



Radius : 15R +/- 2R (Clean corners)

② PACKING : LESS THAN 3 TONS PER BUNDLE WITH ANTIRUST WRAP



③ INSPECTION MARKING, SIGNATURE AND INSPECTION CERTIFICATE



BUREAU VERITAS

« QUALITY ASSURANCE AND CONTROL »



ISO 9001



Hosken Steel Co., Ltd.

1155, Hae-an-ro, Heunghane-eup, Buk-gu, Pohang-si,
Gyeongsangbuk-do, Republic of Korea

T. +82 54 232 9350
sales@hosken.co.kr

F. +82 54 232 9351
www.hosken.co.kr